



INSTRUCTION MANUAL

VHF AIR BAND TRANSCEIVER

IC-A14 IC-A14S

This device complies with Part 15 of the FCC Rules. Operation is subject to the condition that this device does not cause harmful interference.

Icom Inc.



▲IC-A14

▲IC-A14S

SAFETY TRAINING INFORMATION



WARNING

Your Icom radio generates RF electromagnetic energy during transmit mode. This radio is designed for and classified as “Occupational Use Only”, meaning it must be used only during the course of employment by individuals aware of the hazards, and the ways to minimize such hazards. This radio is NOT intended for use by the “General Population” in an uncontrolled environment.

This radio has been evaluated for compliance at the distance of 2.5 cm with the FCC RF exposure limits for “Occupational Use Only”. In addition, your Icom radio complies with the following Standards and Guidelines with regard to RF energy and electromagnetic energy levels and evaluation of such levels for exposure to humans:

- FCC OET Bulletin 65 Edition 97-01 Supplement C, Evaluating Compliance with FCC Guidelines for Human Exposure to Radio Frequency Electromagnetic Fields.
- American National Standards Institute (C95.1-1992), IEEE Standard for Safety Levels with Respect to Human Exposure to Radio Frequency Electromagnetic Fields, 3 kHz to 300 GHz.
- American National Standards Institute (C95.3-1992), IEEE Recommended Practice for the Measurement of Potentially Hazardous Electromagnetic Fields— RF and Microwave.
- The following accessories are authorized for use with this product. Use of accessories other than those specified may result in RF exposure levels exceeding the FCC requirements for wireless RF exposure.; Belt Clip (MB-94/96F) and Rechargeable Li-ion Battery Pack (BP-230N/232N).



CAUTION

To ensure that your expose to RF electromagnetic energy is within the FCC allowable limits for occupational use, always adhere to the following guidelines:

- **DO NOT** operate the radio without a proper antenna attached, as this may damage the radio and may also cause you to exceed FCC RF exposure limits. A proper antenna is the antenna supplied with this radio by the manufacturer or antenna specifically authorized by the manufacturer for use with this radio.
- **DO NOT** transmit for more than 50% of total radio use time (“50% duty cycle”). Transmitting more than 50% of the time can cause FCC RF exposure compliance requirements to be exceeded. The radio is transmitting when “**Tx**” appears on the function display. You can cause the radio to transmit by pressing the “PTT” switch.
- **ALWAYS keep** the antenna at least 2.5 cm (1 inch) away from the body when transmitting and only use the Icom belt-clips which are listed on page 36 when attaching the radio to your belt, etc., to ensure FCC RF exposure compliance requirements are not exceeded. To provide the recipients of your transmission the best sound quality, hold the antenna at least 5 cm (2 inches) from your mouth, and slightly off to one side.

The information listed above provides the user with the information needed to make him or her aware of RF exposure, and what to do to assure that this radio operates with the FCC RF exposure limits of this radio.

Electromagnetic Interference/Compatibility

During transmissions, your Icom radio generates RF energy that can possibly cause interference with other devices or systems. To avoid such interference, turn off the radio in areas where signs are posted to do so. **DO NOT** operate the transmitter in areas that are sensitive to electromagnetic radiation such as hospitals and blasting sites.

Occupational/Controlled Use

The radio transmitter is used in situations in which persons are exposed as consequence of their employment provided those persons are fully aware of the potential for exposure and can exercise control over their exposure.

FOREWORD

Thank you for purchasing this Icom product. The IC-A14/S VHF AIR BAND TRANSCEIVER is designed and built with Icom's state of the art technology and craftsmanship. With proper care this product should provide you with years of trouble-free operation.

IMPORTANT

READ ALL INSTRUCTIONS carefully and completely before using the transceiver.

SAVE THIS INSTRUCTION MANUAL— This instruction manual contains important operating instructions for the IC-A14/S.

EXPLICIT DEFINITIONS

WORD	DEFINITION
⚠ WARNING	Personal injury, fire hazard or electric shock may occur.
CAUTION	Equipment damage may occur.
NOTE	If disregarded, inconvenience only. No risk of personal injury, fire or electric shock.

SUPPLIED ACCESSORIES

The following accessories are supplied with the transceiver.

	Qty.
① Flexible antenna	1
② Battery pack	1
③ Belt clip	1
④ Hand strap	1
⑤ Battery charger	1
⑥ AC adapter	1

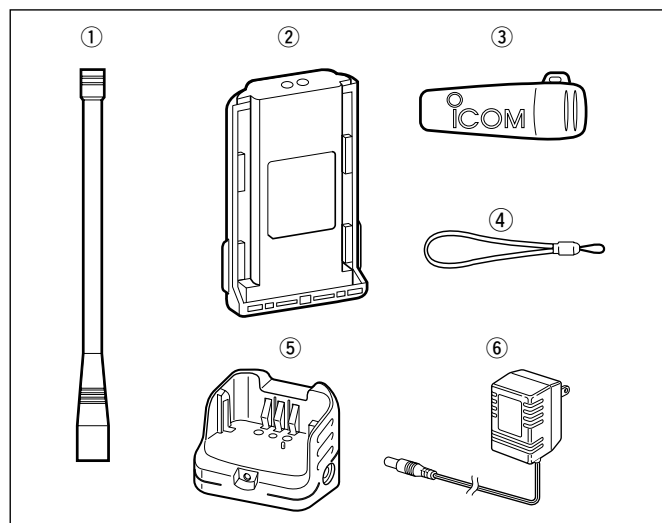

PRECAUTION

⚠ WARNING! NEVER hold the transceiver so that the antenna is very close to, or touching exposed parts of the body, especially the face or eyes, while transmitting. The transceiver will perform best if the microphone is 5 to 10 cm ($2\frac{3}{32}$ to $3\frac{15}{16}$ inch) away from the lips and the transceiver is vertical.

⚠ WARNING! NEVER operate the transceiver with a headset or other audio accessories at high volume levels. Hearing experts advise against continuous high volume operation. If you experience a ringing in your ears, reduce the volume level or discontinue use.

NEVER short the terminals of the battery pack. Also, current may flow into nearby metal objects, such as a necklace, etc. Therefore, be careful when carrying with, or placing near metal objects, carrying in handbags, etc.

NEVER use of non-Icom battery packs/chargers to prevent the loss of the transceiver's good performance and warranty.

DO NOT allow children to play with any radio equipment containing a transmitter.

DO NOT operate the transceiver near unshielded electrical blasting caps or in an explosive atmosphere.

DO NOT use or place the transceiver in direct sunlight or in areas with temperatures below -10°C ($+14^{\circ}\text{F}$) or above $+60^{\circ}\text{C}$ ($+140^{\circ}\text{F}$).

KEEP the transceiver away from heavy rain, and **NEVER** immerse it in water. The transceiver construction is water resistant, not waterproof.

FCC caution: Changes or modifications to this transceiver, not expressly approved by Icom Inc., could void your authority to operate this transceiver under FCC regulations. (U.S.A. only)

Icom, Icom Inc. and the  ICOM logo are registered trademarks of Icom Incorporated (Japan) in the United States, the United Kingdom, Germany, France, Spain, Russia and/or other countries.

TABLE OF CONTENTS

SAFETY TRAINING INFORMATION	i	■ Clearing the memory contents (Available with the IC-A14 only)	17
FOREWORD	ii		
IMPORTANT	ii	5 SCAN OPERATION	18–20
EXPLICIT DEFINITIONS	ii	■ Scan types	18
SUPPLIED ACCESSORIES	ii	■ COM band scan	18
PRECAUTION	iii	■ Memory scan	19
TABLE OF CONTENTS	iv	■ Weather channel scan (Available with the IC-A14 only) ...	19
1 PANEL DESCRIPTION	1–5	■ “TAG” channel setting	20
■ Panel description	1	6 OTHER FUNCTIONS	21–26
■ Function display	5	■ Home function	21
2 ACCESSORY ATTACHMENT	6–7	■ Accessing 121.5 MHz emergency frequency (Available with the IC-A14 only)	21
3 BASIC OPERATION	8–11	■ Key touch beep tone	22
■ Setting a frequency	8	■ ANL function	22
■ Setting a squelch level	9	■ Weather channel operation (Available with the IC-A14 only)	23
■ Lock function	9	■ Duplex operation (Available with the IC-A14 only)	24
■ Receiving	10	■ Set mode setting	25
■ Transmitting	10	7 BATTERY PACKS	27–31
■ Side tone function	11	■ Battery charging.....	27
■ LCD backlight.....	11	■ Charging the battery	29
■ Low battery indicator.....	11	8 CLONING	32–33
4 MEMORY OPERATION	12–17	9 TROUBLESHOOTING	34
■ Memory channel selection	12	10 SPECIFICATIONS	35
■ Memory bank selection (Available with the IC-A14 only)	12	11 OPTIONS	36
■ Programming a memory channel	13	12 OPTIONAL HEADSET CONNECTION	37
■ Memory names	15		
■ Copying memory contents	16		

1 PANEL DESCRIPTION

■ Panel description

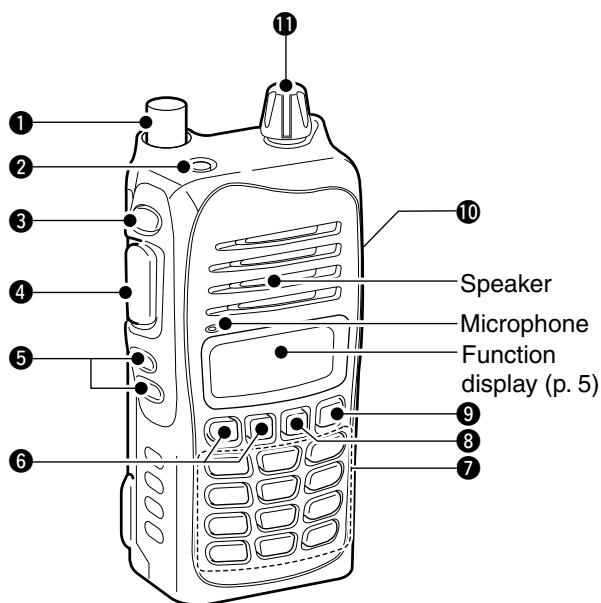

- ❶ **ANTENNA CONNECTOR [ANT]** (p. 6)
Connects the supplied antenna.
- ❷ **KEY LOCK SWITCH [LOCK]** (p. 9)
 - ➔ Push to turning the key lock function ON.
 - ➔ Push and hold for 2 sec. to turning the key lock function OFF.
- ❸ **LIGHT SWITCH [LIGHT]**
Push to toggles the LCD backlight ON and OFF. (p. 11)
For IC-A14S only
During memory mode, push and hold for 2 sec. to turn the "TAG" setting ON and OFF. (p. 20)
- ❹ **PTT SWITCH [PTT]**
Push and hold to transmit; release to receive.
- ❺ **SQUELCH UP/DOWN KEYS [SQL▲]/[SQL▼]** (p. 9)
Push either key to select the squelch level.
 - 10 squelch levels, 1–10, and squelch open, 0, are available.
- ❻ **UP/DOWN KEYS [▲]/[▼]**
 - ➔ Push to change or select the operating frequency, memory channel, set mode setting, etc. (p. 8)
 - ➔ While scanning, push to change the scanning direction. (pgs. 18, 19)**For IC-A14S only**
Push and hold for 1 sec. to start scanning. (pgs. 18, 19)

7 **KEYPAD** (Available with the IC-A14 only; pgs. 3, 4)

8 **MEMORY MODE/MEMORY WRITE KEY [MR]/[MW]**

Push to select memory mode. (p. 12)

For IC-A14

→ Push **[FUNC]** then push this key enters select memory write mode. (p. 13)

→ During memory mode, push **[FUNC]** then push this key to copy the memory content into frequency mode. (p. 16)

For IC-A14S

→ Push and hold for 1 sec. to enter select memory write mode. (p. 14)

→ During memory mode, push and hold for 1 sec. to copy the memory content into frequency mode. (p. 16)

9 **CLEAR/HOME SWITCH [CLR]/[HOME]**

→ Push to select frequency mode. (p. 8)

→ Push and hold for 2 sec. to resetting the transceiver into the user-default condition without memory contents (home function). (p. 21)

10 **EXTERNAL SPEAKER AND MICROPHONE JACKS [MIC/SP]** (p. 37)

Connects the optional speaker microphone or a headset using with the optional OPC-499 HEADSET ADAPTER, if desired.

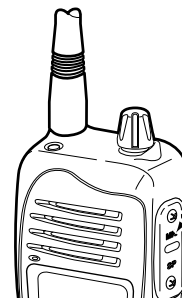

Jack cover

NOTE: Attach the jack cover when the optional equipment is not used.

NEVER connect an optional speaker-microphone, headset adapter, etc. while the transceiver power is ON.

11 **VOLUME CONTROL KNOB [VOL]**

Rotate to turn the transceiver power ON/OFF and adjusts the audio level.

1 PANEL DESCRIPTION

◇ KEYPAD (Available with IC-A14 only)

- 1 ANL** → Inputs digit “1” for frequency input or memory channel selection, etc. (pgs. 8, 12)
 - Inputs “1,” “Q,” or “Z” during memory name programming. (p. 15)
 - After pushing **[FUNC]**, turns the ANL (Automatic Noise Limiter) function ON and OFF. (p. 22)
- 2 SCAN** → Inputs digit “2” for frequency input or memory channel selection, etc. (pgs. 8, 12)
 - Inputs “2,” “A,” “B,” or “C” during memory name programming. (p. 15)
 - After pushing **[FUNC]**, starts the scan. (pgs. 18, 19)
- 3 BANK** → Inputs digit “3” for frequency input or memory channel selection, etc. (pgs. 8, 12)
 - Inputs “3,” “D,” “E,” or “F” during memory name programming. (p. 15)
 - After pushing **[FUNC]**, selects memory bank mode, during memory mode. (p. 12)
- 4 WX-ALT** → Inputs digit “4” for frequency input or memory channel selection, etc. (pgs. 8, 12)
 - Inputs “4,” “G,” “H,” or “I” during memory name programming. (p. 15)
 - After pushing **[FUNC]**, turns the weather alert function ON and OFF. (p. 23)
- 5 DUP-W** → Inputs digit “5” for frequency input or memory channel selection, etc. (pgs. 8, 12)
 - Inputs “5,” “J,” “K,” or “L” during memory name programming. (p. 15)
 - After pushing **[FUNC]**, enters duplex transmit frequency programming condition, during NAVI band operation. (p. 24)
- 6 DUP** → Inputs digit “6” for frequency input or memory channel selection, etc. (pgs. 8, 12)
 - Inputs “6,” “M,” “N,” or “O” during memory name programming. (p. 15)
 - After pushing **[FUNC]**, selects duplex operation during NAVI band operation. (p. 24)
- 7 WX** → Inputs digit “7” for frequency input or memory channel selection, etc. (pgs. 8, 12)
 - Inputs “7,” “P,” “R,” or “S” during memory name programming. (p. 15)
 - After pushing **[FUNC]**, selects weather channel mode. (p. 23)
- 8 BEEP** → Inputs digit “8” for frequency input or memory channel selection, etc. (pgs. 8, 12)
 - Inputs “8,” “T,” “U,” or “V” during memory name programming. (p. 15)
 - After pushing **[FUNC]**, key touch beep output ON and OFF. (p. 22)

- 9 TAG** → Inputs digit “9” for frequency input or memory channel selection, etc. (pgs. 8, 12)
 - Inputs “9,” “W,” “X,” or “Y” during memory name programming. (p. 15)
 - After pushing **[FUNC]**, toggles scan tag setting ON and OFF. (p. 20)
- 0 121.5** → Inputs digit “0” for frequency input or memory channel selection, etc. (pgs. 8, 12)
 - Inputs “0,” “space” or “-” during memory name programming. (p. 15)
 - After pushing **[FUNC]**, selects the emergency frequency, 121.500 MHz. (p. 21)
- ENTSET** → Completes the numeral input for frequency or memory channel number, etc. Enters consecutive zero into the following digits. (pgs. 8, 12)
 - After pushing **[FUNC]**, push and hold for 1 sec. to entering into set mode. (p. 25)
- FUNC** → Push to call up the function indicator, “**F**”, then push another key to access its secondary function.

1 PANEL DESCRIPTION

■ Function display

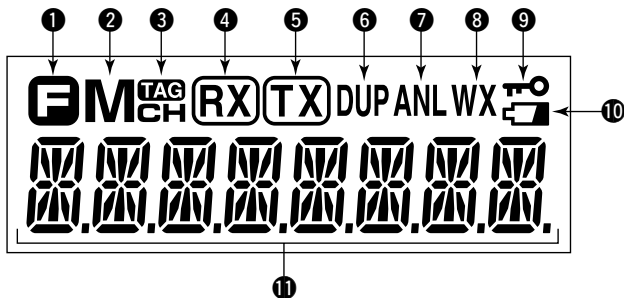

- 1 FUNCTION INDICATOR**
Appears when [FUNC] is pushed.
- 2 MEMORY INDICATOR** (p. 12)
Appears when memory channel mode is selected.
- 3 TAG INDICATOR** (p. 20)
Appears when the selected memory channel is set as a TAG channel.
- 4 RX INDICATOR** (p. 10)
Appears when receiving a signal or when the squelch opens.
- 5 TX INDICATOR** (p. 10)
Appears while transmitting.
- 6 DUPLEX INDICATOR** (IC-A14 only) (p. 24)
 - Appears when the duplex function is activate.
 - Blinks while setting the duplex frequency.
- 7 ANL INDICATOR** (p. 22)
Appears when the ANL (Automatic Noise Limiter) function is in use.
- 8 WEATHER ALERT INDICATOR** (IC-A14 only) (p. 23)
Appears when the weather alert function is in use.
- 9 LOCK INDICATOR** (p. 9)
Appears when the lock function is in use.
- 10 LOW BATTERY INDICATOR** (p. 11)
 - Appears when the battery is nearing exhaustion. The attached battery pack requires recharging when this indicator ON.
 - Blinks when battery replacement is necessary.
- 11 FREQUENCY READOUT**
Shows the operating frequency, memory channel number, memory name, set mode item, etc., depending on the selected condition.

ACCESSORY ATTACHMENT

2

◇ Antenna

Insert the supplied antenna into the antenna connector and screw down the antenna as shown at right.

CAUTION!

- **NEVER** carry the transceiver by the antenna.
- **DO NOT** transmit without an antenna. Otherwise the transceiver may be damaged.

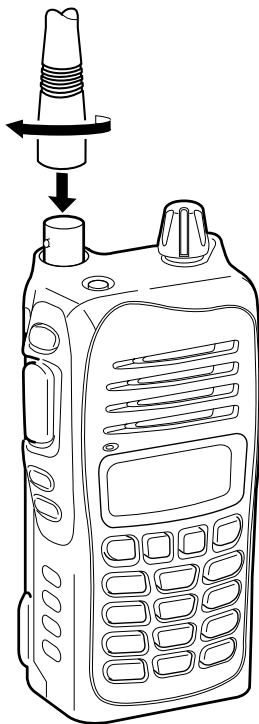

◇ Belt clip

Conveniently attaches to your belt.

Attach the belt clip as described below.

- ① Release the battery pack if it is attached.
- ② Slide the belt clip in the direction of the arrow until the belt clip is locked and makes a 'click' sound.

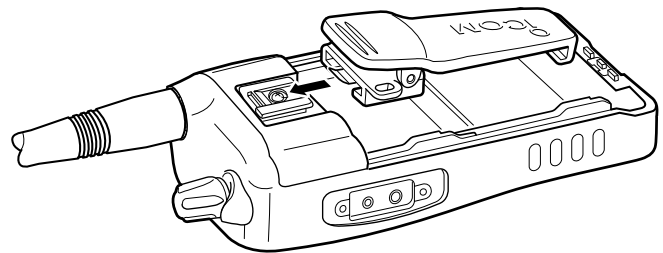

- When detaching the belt clip

- ① Release the battery pack if it is attached.
- ② Pinch the clip (1), and slide the belt clip in the direction of the arrow (2).

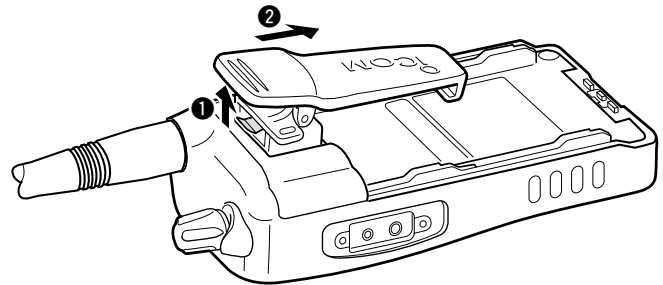

1
2

2 ACCESSORY ATTACHMENT

◇ Battery pack attachment

Turn the transceiver power OFF with [VOL] before attaching or detaching the battery pack.

Slide the battery pack in the direction of the arrow (❶), then lock it with the battery release button.

- Slide the battery pack until the battery release button makes a 'click' sound.

To release the battery pack:

Slide the battery release button in the direction of the arrow (❷) as shown in the illustration at right. The battery pack is then released.

NEVER release or attach the battery pack when the transceiver is wet or soiled. This may result water or dust getting into the transceiver/battery pack and may result in the transceiver being damaged.

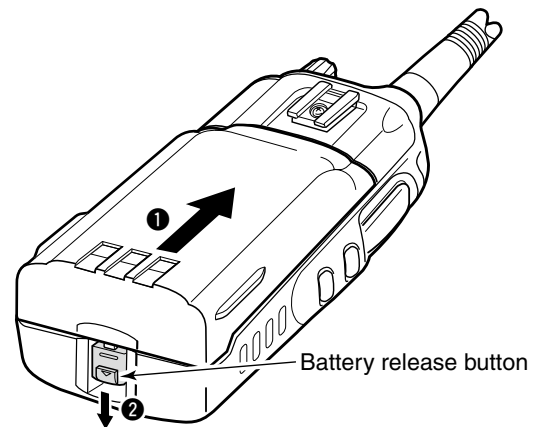

For your information

If the transceiver power cannot be turned ON when replacing with the fully charged battery pack, perform as follow. Detach the battery pack and wait for a while (approx. 10 sec.), then attach the battery pack then turn power ON.

■ Setting a frequency

◇ Using [▲]/[▼] keys

- ① Rotate [VOL] to turn power ON, then push [CLR] to select the frequency mode when memory CH number or WX CH number appears on the function display.
- ② Push [▲]/[▼] to set the desired frequency.
 - For IC-A14 only -
 - 1 MHz tuning step is available with the IC-A14; push [FUNC], then push [▲]/[▼]. Push [FUNC] again to return the normal tuning.

◇ Using keypad (IC-A14 only)

- ① Rotate [VOL] to turn power ON, then push [CLR] to select the frequency mode when memory CH number or WX CH number appears on the function display.
- ② Push 5 appropriate digit keys to input the frequency.
 - Push [1] as the 1st digit.
 - When a wrong digit is input, push [CLR] to clear, then repeat step ② again.
 - Push [ENT] to enter consecutive zero digits.
 - Only [2], [5], [7] and [0] can be entered as the 5th and final digit.

[EXAMPLE]

- 111.225 MHz: Push [1], [1], [1], [2], [2]
- 117.250 MHz: Push [1], [1], [7], [2], [5]
- 120.000 MHz: Push [1], [2], [ENT]
- 125.300 MHz: Push [1], [2], [5], [3], [ENT]

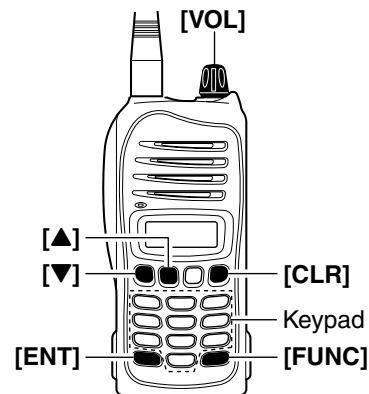

3 BASIC OPERATION

■ Setting a squelch level

The transceiver has a noise squelch circuit to mute undesired noise while receiving no signal.

- ① Push [SQL▲] or [SQL▼] to select the squelch level.
 - 'SQL--0' is open squelch and 'SQL--10' is tight squelch.
 - "RX" indicator appears while the squelch is open.
- ② Wait for 1 sec. to return to the previous indication.

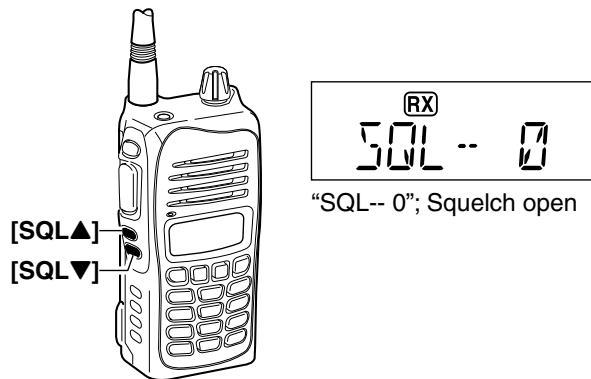

■ Lock function

The lock function prevents accidental frequency changes and accidental function activation.

- ① Push [T-O] to turn the lock function ON.
 - "T-O" indicator appears.
- ② To turn the function OFF, push and hold [T-O] for 2 sec.
 - "T-O" indicator disappears.

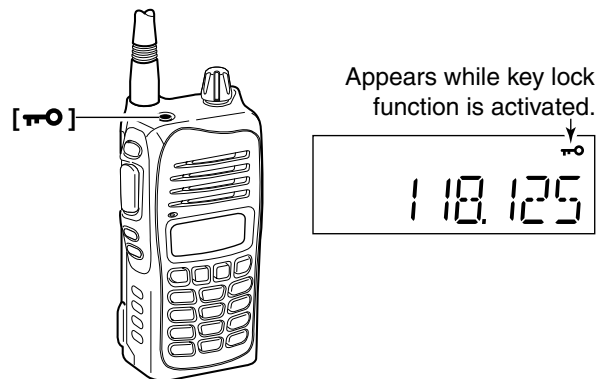

■ Receiving

- ① Rotate [VOL] to turn the power ON.
- ② Push [SQL▼] several times to open the squelch.
 - Select the squelch level 0.
- ③ Rotate [VOL] to adjust the audio level.
- ④ Push [SQL▲] several times until the noise is muted.
 - “RX” indicator disappears.
- ⑤ Set the desired frequency using [▲]/[▼] keys or keypad.
- ⑥ When a signal is received on the set frequency:
 - “RX” indicator appears.
 - Squelch opens and audio is emitted from the speaker.

Appears when receiving a signal.

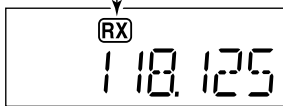

When squelch setting is too “tight” (large number setting), squelch may not open for weak signals. To receive weaker signals, loosen (small number setting) the squelch.

■ Transmitting

NOTE: To prevent interference, listen on the frequency before transmitting. If the frequency is busy, wait until the channel is clear.

CAUTION: Transmitting without an antenna may damage the transceiver.

- ① Set the desired frequency in COM band using [▲]/[▼] or keypad (IC-A14 only).
 - COM band frequency range: 118.00–136.975 MHz
- ② Push and hold [PTT] to transmit.
 - “TX” indicator appears.
- ③ Speak into the microphone at a normal voice level.
 - **DO NOT** hold the transceiver too close to your mouth or speak too loudly. This may distort the signal.
- ④ Release [PTT] to return to receive.

NOTE: About Time-Out-Timer function

For the prevention of prolonged transmission, etc., according to regulatory requirements, the IC-A14/S has a Time-Out-Timer function. This timer cuts a transmission OFF after the set time period of continuous transmission. The time-out timer is specified in set mode. See page 26 for details.

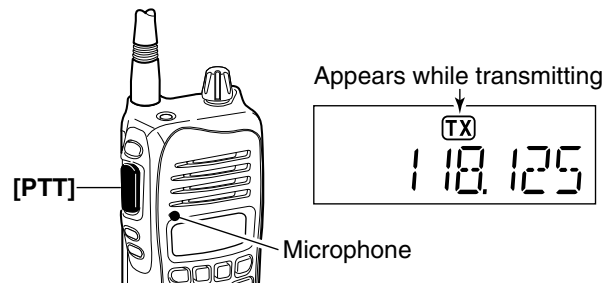

3 BASIC OPERATION

■ Side tone function

When using a headset (other manufacture's products), the transceiver outputs your transmitted voice to the headset for monitoring. Connect the optional headset with the transceiver when using this function (OPC-499 HEADSET ADAPTER and headset are required). (p. 37)

◇ Setting the side tone level

- ① Push [PTT] to turn the transmit mode ON.
- ② During transmit, push [▲]/[▼] to adjust the level.
 - 'ST--0' is OFF and 'ST--10' is maximum level.



Side tone level is indicated

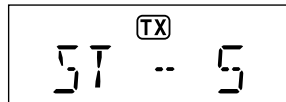

IMPORTANT!

Select 'ST--0' when a speaker microphone is connected, otherwise your voice will be heard from the speaker during transmit.

WARNING! NEVER operate the transceiver with a headset at high volume/monitor levels for long period. A ringing in your ears may occur. If so, reduce the volume/monitor level or discontinue use.

■ LCD backlight

The IC-A14/S has LCD backlight for convenience during night time operation.

- Push [LIGHT] to turn the LCD backlight ON and OFF.

IMPORTANT!

Light OFF the LCD backlight when no backlight is necessary.

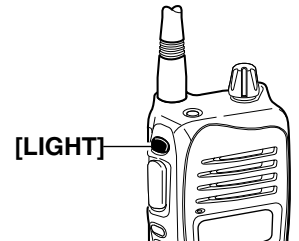

■ Low battery indicator

Low battery indicator appears or blinks when the battery power has decreased to a specified level. The attached battery pack requires recharging.

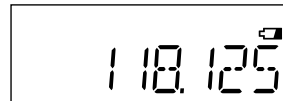

← Appears when the battery is nearly exhausted. Blinks when the battery replacement is necessary.

If no battery charging is performed even the low battery indicator blinks, emits a long beep then the transceiver power turned OFF automatically.

■ Memory channel selection

IC-A14 has 200 memory channels (20 channels × 10 banks; default setting) and IC-A14S has 100 memory channels for storage of often-used frequencies.

- ① Push **[MR]** to select memory mode.
 - Memory indicator appears and memory channel number is displayed briefly.
 - Memory bank number also displays with IC-A14.

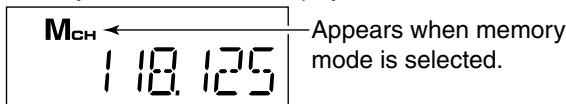

Using **[▲]/[▼]**:

- ② Push **[▲]/[▼]** to select the desired memory CH number.
 - Memory channel number is displayed briefly, then programmed frequency (or memory name, if programmed) is displayed.
 - If no memory CH is programmed, no memory CH selection is available.

Using the Keypad— IC-A14 only:

- ② Push 2 appropriate digit key (00 to 99, depending on bank setting condition) to select the desired memory CH number, then push **[ENT]**.
 - Memory channel number is displayed briefly, then programmed frequency (or memory name, if programmed) is displayed.
 - If no memory CH is programmed in the selected BANK, no memory CH selection is available.

■ Memory bank selection

(Available with the IC-A14 only)

A 200 of the IC-A14's memory channels are divided into bank (up to 10 banks are available depending on setting) for simple memory grouping.

- ① Push **[MR]** to select memory mode.
- ② Push **[FUNC]**, and push **[BANK](3)** to enter bank selection mode.

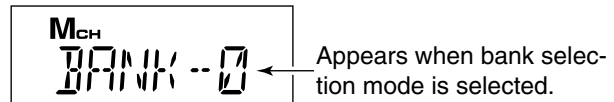

- ③ Push **[▲]/[▼]** or appropriate digit key (**[0]** to **[9]**) to enter the desired memory BANK number, then push **[ENT]**.
- ④ Push **[▲]/[▼]**, or 2 appropriate digit key and **[ENT]** to select the desired memory channel.

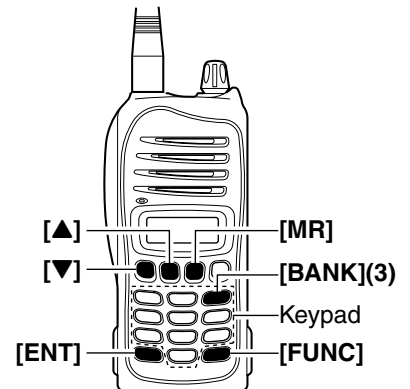

4 MEMORY OPERATION

■ Programming a memory channel

Program often-used frequencies with the following instructions.

◇ For IC-A14

- ① Push [CLR] to select the frequency mode, if necessary.
- ② Set the desired frequency. (p. 8)
 - Push [FUNC], then push [WX](7) to select a weather channel mode, and then select the desired weather channel using [▲]/[▼] or keypad if desired. (p. 23)
- ③ Push [FUNC] then push [MW](MR) to enter the select memory write mode.
 - Memory mode indicator blinks.

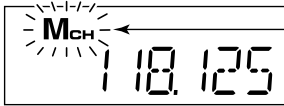

Blinks when select memory write mode is selected.

No frequency is displayed when a blank channel is selected.

- ④ Push [▲]/[▼] to select the desired memory channel number.
 - Push [FUNC], then push [BANK](3) to enter bank selection mode, and push [▲]/[▼] or appropriate digit key ([0]–[9]), then push [ENT] to select the BANK number if desired.
- ⑤ Push [ENT] to program the set condition into the memory channel and return to the frequency mode.

• EXAMPLE: Programming WX-05 into memory channel 9 in memory BANK 3.

Push

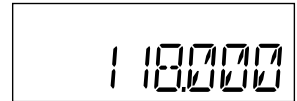

Push then

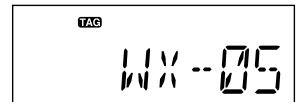

Push or ,

or, push

Push then



Push then



Push then

*Shows briefly.

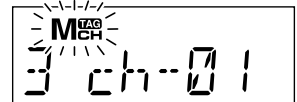

Push or ,

or, push

*Shows briefly.

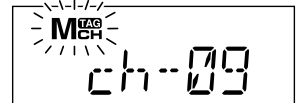

Push to complete the programing.

◇ For IC-A14S

- ① Push [CLR] to select the frequency mode, if necessary.
- ② Set the desired frequency. (p. 8)
- ③ Push and hold [MR] for 1 sec. to enter the select memory write mode.
 - Memory mode indicator blinks.

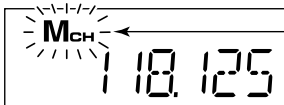

Blinks when select memory write mode is selected.

No frequency is displayed when a blank channel is selected.

- ④ Push [▲]/[▼] to select the desired memory channel number.
- ⑤ Push and hold [MR] for 1 sec. to program the set condition into the memory channel and return to the frequency mode.

• **EXAMPLE:** Programming 123.450 MHz into memory channel 51.

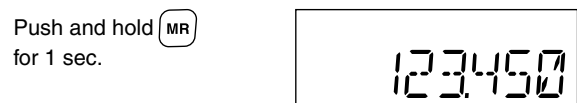

4 MEMORY OPERATION

■ Memory names

The memory channel can display an 8-character name instead of the programmed frequency.

◇ Programming memory names

- ① Set the desired frequency in frequency mode. (p. 8)
- ② Enter the select memory write mode.
 - For IC-A14; push **[FUNC]** then push **[MW](MR)**.
 - For IC-A14S; push and hold **[MR]** for 1 sec.
- ③ Select the desired memory channel to be programmed with **[▲]/[▼]** (or keypad and **[ENT]**; for IC-A14 only).
- ④ Push **[MR]** momentarily to enter the memory name programming mode.
 - “-----” appears and 1st digit blinks.

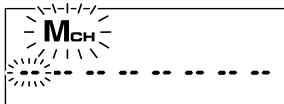

• Available characters

KEY	CHARACTER	KEY	CHARACTER
[1]	1, Q, Z	[6]	6, M, N, O,
[2]	2, A, B, C	[7]	7, P, R, S
[3]	3, D, E, F	[8]	8, T, U, V
[4]	4, G, H, I	[9]	9, W, X, Y
[5]	5, J, K, L	[0]	0, _ (space), -

For IC-A14

- ⑤ Push the appropriate digit key several times to select the desired character as listed at right.
 - To move the cursor forwards or backwards, use **[▲]/[▼]**.
 - The cursor moves forwards automatically when a different key is pushed.
 - To erase a character, overwrite with a space (displayed as “_”).
- ⑥ Push **[ENT]** to program the name and frequency at the same time.
 - Return to the frequency indication.
 - When no name is programmed, the display shows the programmed frequency.
 - To clear the entered memory names, push **[CLR]** before pushing **[ENT]**.

For IC-A14S

- ⑤ Push **[▲]/[▼]** several times to select the desired character.
 - To move the cursor forwards, use **[MR]**.
 - To erase a character, overwrite with a space (displayed as “_”).
- ⑥ Push and hold **[MR]** for 1 sec. to program the name and frequency at the same time.
 - Return to the frequency indication.
 - When no name is programmed, the display shows the programmed frequency.
 - To clear the entered memory names, push **[CLR]** before pushing and holding **[MR]** for 1 sec.

NOTE: When programming a memory name to the programmed memory channel, operate as follow.

- ① Select the desired memory channel that requires a name. (see p. 12).

For IC-A14

- ② Push **[FUNC]** then push **[MW](MR)**.
 - The selected memory contents copied into frequency mode and frequency mode is selected automatically.
- ③ Push **[FUNC]** then push **[MW](MR)** again.
- ④ Push **[MR]** momentarily to select memory name programming mode.
- ⑤ Perform the steps ⑤ and ⑥ described at left page in “**For IC-A14**” to program the desired memory name.

For IC-A14S

- ② Push and hold **[MR]** for 1 sec.
 - The selected memory contents copied into frequency mode and frequency mode is selected automatically.
- ③ Push and hold **[MR]** for 1 sec. again.
- ④ Push **[MR]** momentarily to select memory name programming mode.
- ⑤ Perform the steps ⑤ and ⑥ described at left page in “**For IC-A14S**” to program the desired memory name.

■ Copying memory contents

This function copies a memory channel's contents into the frequency mode. This is useful when searching for signals around a memory channel's frequency.

- ① Push **[MR]** to select memory mode.
- ② Select the desired memory channel to be transferred using **[▲]/[▼]** (or keypad and **[ENT]**; for IC-A14 only).
 - Select the desired bank if desired.

For IC-A14

- ③ Push **[FUNC]**, then push **[MW](MR)** to copy the memory channel's contents into the frequency mode.
 - Frequency mode is automatically selected.

For IC-A14S

- ③ Push and hold **[MR]** for 1 sec. to copy the memory channel's contents into the frequency mode.
 - Frequency mode is automatically selected.

4 MEMORY OPERATION

■ Clearing the memory contents

(Available with the IC-A14 only)

Unwanted memory channels can be cleared.

- ① Select the desired memory channel to be cleared. (p. 12)
 - Select the desired bank if desired. (p. 12)
- ② Push **[FUNC]** then push and hold **[CLR]** for 1 sec.
 - “- - - - -” appears briefly, then the next selectable channel appears.

■ Scan types

The IC-A14 has 3 scan types to suit your needs. IC-A14S has 2 scan types.

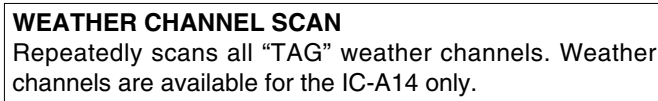
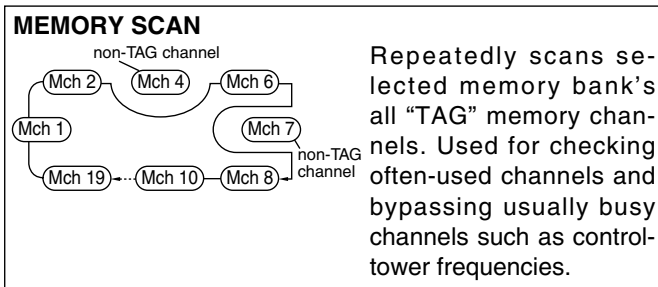
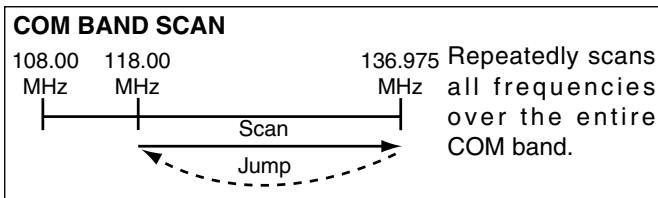

■ COM band scan

- ① Push **[CLR]** to select the frequency mode.
- ② Push **[SQL▲]/[SQL▼]** to set the squelch level to the point where noise is just muted.

For IC-A14

- ③ Push **[FUNC]**, then push **[SCAN](2)** to start the scan.
 - When a signal is received, the scan pauses until it disappears.
 - To change the scanning direction, push **[▲]/[▼]**.

For IC-A14S

- ③ Push and hold **[▲]/[▼]** for 1 sec. to start the scan.
 - When a signal is received, the scan pauses until it disappears.
 - To change the scanning direction, push **[▲]/[▼]**.
- ④ To stop the scan, push **[CLR]**.



Decimal point blinks during scan.

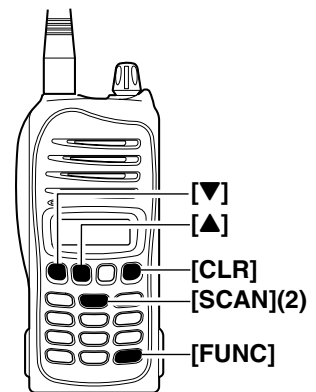

5 SCAN OPERATION

■ Memory scan

NOTE: Program 2 or more memory channels with “TAG” setting to start memory scan.

- ① Push **[MR]** to select memory mode.
 - For IC-A14, select the desired BANK if desired. (p. 12)
- ② Push **[SQL▲]/[SQL▼]** to set the squelch level to the point where noise is just muted.

For IC-A14

- ③ Push **[FUNC]**, then push **[SCAN](2)** to start the scan.
 - When a signal is received, the scan pauses until it disappears.
 - To change the scanning direction, push **[▲]/[▼]**.

For IC-A14S

- ③ Push and hold **[▲]/[▼]** for 1 sec. to start the scan.
 - When a signal is received, the scan pauses until it disappears.
 - To change the scanning direction, push **[▲]/[▼]**.

- ④ To stop the scan, push **[CLR]**.

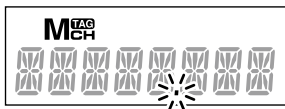

Decimal point blinks during scan.

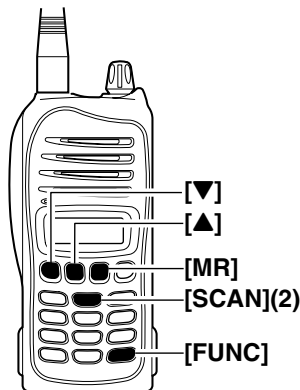

■ Weather channel scan

(Available with the IC-A14 only)

- ① Push **[FUNC]**, then push **[WX](7)** to select a weather channel mode.
- ② Set squelch to the point where noise is just muted with **[SQL▲]/[SQL▼]**.
- ③ Push **[FUNC]**, then push **[SACN(2)]** to start the scan.
 - When a signal is received, the scan pauses until it disappears.
 - To change the scanning direction, push **[▲]/[▼]**.
- ④ To stop the scan, push **[CLR]**.



Decimal point blinks during scan.

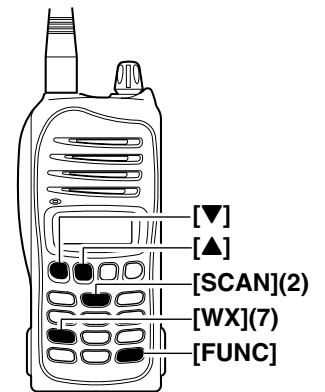

■ “TAG” channel setting

Memory and weather channels* can be specified to be skipped for the memory and weather channel* scans respectively. The “TAG” channel function is only available during scan operation. *for IC-A14 only

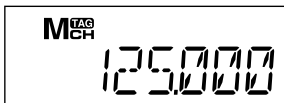

“TAG” indicator appears with the scanned channel.

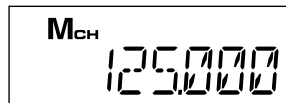

No “TAG” indicator appears with the skipped channel.

For IC-A14

- ① Push **[MR]** to select memory mode; or, push **[FUNC]**, then push **[WX](7)** to select a weather channel.
 - Select the desired BANK if desired.
- ② Select the desired memory/weather channel to be a “TAG” channel.
 - Select the desired BANK if desired.
- ③ Push **[FUNC]**, then push **[TAG](9)** to set a “TAG.”
 - “TAG” appears.
 - Non-“TAG” channels are skipped during scan.
- ④ To cancel the “TAG” setting, repeat above steps.

For IC-A14S

- ① Push **[MR]** to select memory mode.
- ② Select the desired memory channel to be a “TAG” channel.
- ③ Push and hold **[LIGHT]** for 2 sec. to set a “TAG.”
- ④ To cancel the “TAG” setting, repeat the above steps.

6

OTHER FUNCTIONS

■ Home function

The home function is convenient if you want to return the transceiver to default condition without memory channels. The following transceiver's settings will return to the default value;

- Operating mode (Frequency, memory or weather* channel mode with frequency or channel number, including bank*)
- Duplex setting • ANL setting • Key touch beep
- Squelch level • Side tone level • Microphone gain
- Internal microphone usage • Time-Out timer setting

The default condition can be modified to suits your preference using with the optional cloning software, CS-A14.

- ➔ Push and hold **[CLR]** for 2 sec. to return the transceiver into the default setting.

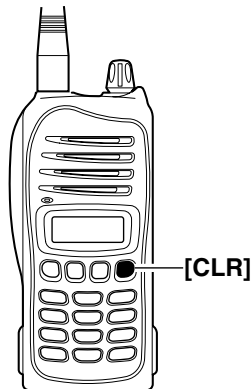

■ Accessing 121.5 MHz emergency frequency

(Available with the IC-A14 only)

The IC-A14 can set to the 121.5 MHz emergency frequency quickly. This function can be activated even when the key lock function is in use.

- ① Push **[FUNC]** then **[121.5](0)** to call the emergency frequency.
- ② Push **[CLR]** to return to frequency mode.

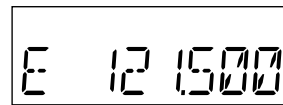

Emergency initial, "E," appears with the frequency

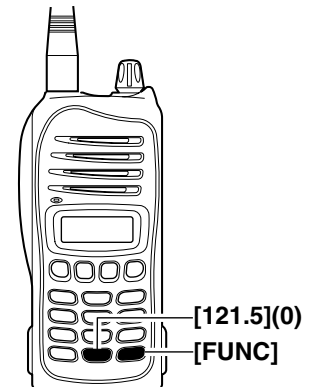

*for IC-A14 only

■ Key touch beep tone

The beep tone, which sounds at the push of a switch can be set, if desired.

For IC-A14

- Push **[FUNC]** then push **[BEEP](8)** to turn the key touch beep tone ON and OFF.
 - Key touch beep setting is displayed briefly.

For IC-A14S

- ① Rotate **[VOL]** to turn the transceiver power OFF.
- ② While pushing and holding **[▲]/[▼]**, rotate **[VOL]** to enter set mode.
- ③ Push **[MR]** several times to select the key touch beep item, "BEEP."
- ④ Push **[▲]/[▼]** to select the desired condition from ON and OFF.
- ⑤ Push **[CLR]** to return to frequency mode.

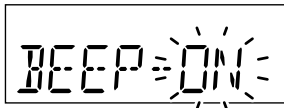

■ ANL function

The ANL (Automatic Noise Limiter) function reduces noise components such as that caused by engine ignition systems while receiving.

For IC-A14

- Push **[FUNC]** then push **[ANL](1)** to turn the ANL function ON/OFF.
 - "ANL" indicator appears when the ANL function is ON.

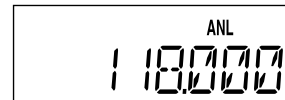

"ANL" indicator appears when the ANL function is in use.

For IC-A14S

- ① Rotate **[VOL]** to turn the transceiver power OFF.
- ② While pushing and holding **[▲]/[▼]**, rotate **[VOL]** to enter set mode.
- ③ Push **[MR]** several times to select the ANL item, "ANL."
- ④ Push **[▲]/[▼]** to select the desired condition from ON and OFF.
 - "ANL" indicator appears when the ANL function is ON.
- ⑤ Push **[CLR]** to return to frequency mode.

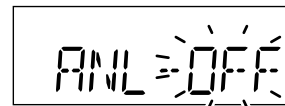

6 OTHER FUNCTIONS

■ Weather channel operation

(Available with the IC-A14 only)

The IC-A14 has VHF marine WX (weather) channel receiving capability for flight planning.

◇ Weather channel selection

- ① Push **[FUNC]**, then push **[WX](7)** to select WX channel mode.
 - “WX--” and previously selected channel number appears.
- ② Push **[▲]/[▼]** to select the desired WX channel.
- ③ Push **[CLR]** to exit the WX channel mode and return to frequency mode.

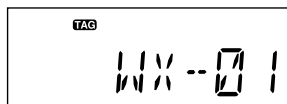

Weather channel appears



◇ Setting weather alert function

An NOAA broadcast station transmits a weather alert tone before any important weather announcements. When the weather alert function is turned ON, the transceiver detects the alert, and sounds a beep tone until the transceiver is operated. The previously selected (used) weather channel is checked any time during standby, or while scanning.

- Push **[FUNC]**, then push **[WX-ALT](4)** to turns the weather alert function ON and OFF.
- “WX” indicator appears when the weather alert function ON.

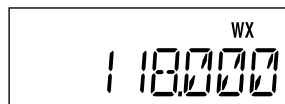

“WX” indicator appears when the weather alert is set to ON



■ Duplex operation (Available with the IC-A14 only)

The duplex function allows you to call a flight service station while receiving a VOR station. The duplex function requires frequency programming for the flight service station in advance.

◇ Programming a duplex frequency

- ① Push **[CLR]** to select the frequency mode.
- ② Set a NAVI band frequency using **[▲]/[▼]** or keypad.
 - NAVI band frequency range: 108.00–117.975 MHz
- ③ Push **[FUNC]**, then push **[DUP-W](5)**.
 - “DUP” blinks and transmit frequency appears.
- ④ Set the desired flight service station frequency using **[▲]/[▼]** or keypad, then push **[ENT]**.
 - The displayed frequency returns to the NAVI band frequency.



“DUP” indicator blinks during transmit frequency setting

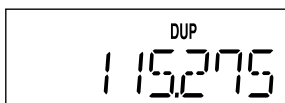

“DUP” appears during duplex operation

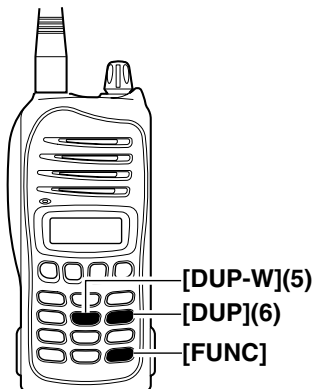

◇ Operating the duplex function

- ① Set the desired frequency in NAVI band.
 - NAVI band frequency range: 108.00–117.975 MHz
- ② Push **[FUNC]**, then push **[DUP](6)** to turn the duplex function ON.
 - “DUP” indicator appears.
- ③ Push and hold **[PTT]** to transmit on the pre-programmed transmit frequency.
- ④ Release **[PTT]** to return to receive.
- ⑤ Push **[FUNC]**, then push **[DUP](6)** to cancel the function.
 - “DUP” indicator disappears.

NOTE: A duplex frequency can be programmed into each memory channel independently. Set a duplex frequency before programming the memory channel, if desired. The duplex ON/OFF setting can also be programmed into a memory channel.

6 OTHER FUNCTIONS

■ Set mode setting

Set mode is used for programming infrequently changed values or conditions of functions.

◇ Entering set mode

- ① Rotate **[VOL]** to turn the transceiver power OFF.
- ② While pushing and holding **[▲]** and **[▼]**, turn **[VOL]** to enter set mode.
- ③ Push **[MR]** several times to select the desired set mode item.
- ④ Push **[▲]/[▼]** to select the desired condition or value for the item.
- ⑤ Push **[CLR]** to return to frequency mode.

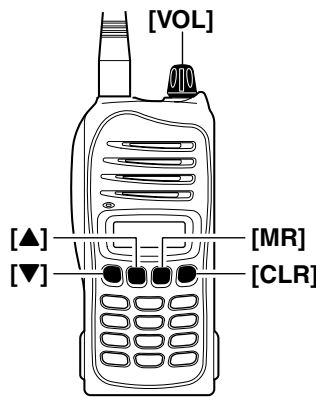

For IC-A14 only

Push **[FUNC]** then push and hold **[SET](ENT)** for 1 sec. to also enter into set mode.

For your information:

The default value of the set mode items can be changed with the optional cloning software, CS-A14. And the default settings are re-called by the home function.

◇ Set mode items

- **ANL— ANL function** (available with IC-A14S only)
Sets the ANL (Automatic Noise Limiter) function that reduces noise components such as that caused by engine ignition systems while receiving.

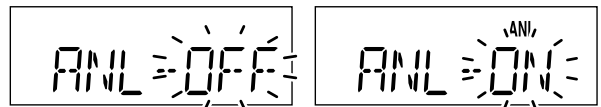

- **BEEP— Key touch beep** (available with IC-A14S only)
The beep tone which sounds at the push of a switch can be set, if desired.

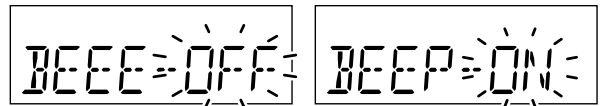

- **MIC— Microphone gain**

The internal microphone gain can be selected to suits your communicating style.

"H" (High gain), "M" (Middle gain) and "L" (Low gain) selections are available.

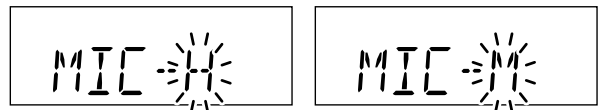

• I.MIC— Internal microphone usage

The internal microphone can be deactivated for headset operation.

This setting prevents unwanted audio/noise transmission entering from the internal microphone with [PTT] operation.

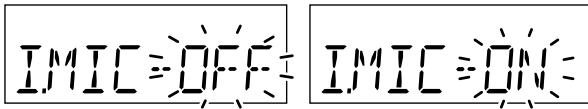
**• TOT— Time-out timer**

Sets the time-out timer period for the prevention of prolonged transmission, etc., according to regulatory requirements. This timer cuts a transmission OFF after the set time period of continuous transmission.

Sets the timer within 20 to 180 (sec.) in 10 sec. steps and OFF.

Ask your dealer for local regulation details.

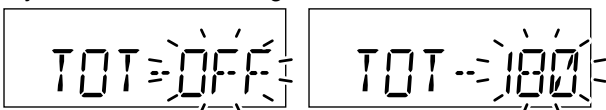

7

BATTERY PACKS

■ Battery charging

Misuse of Lithium-ion batteries may result in the following hazards: smoke, fire, or the battery may rupture. Misuse can also cause damage to the battery or degradation of battery performance.

⚠ **DANGER!** Use and charge only specified Icom battery packs with Icom radios or Icom charger. Only Icom battery packs are tested and approved for use and charge with Icom radios or Icom charger. Using third-party or counterfeit battery packs or charger may cause smoke, fire, or cause the battery to burst.

◇ Battery caution

⚠ **DANGER! DO NOT** hammer or otherwise impact the battery. Do not use the battery if it has been severely impacted or dropped, or if the battery has been subjected to heavy pressure. Battery damage may not be visible on the outside of the case. Even if the surface of the battery does not show cracks or any other damage, the cells inside the battery may rupture or catch fire.

⚠ **DANGER! NEVER** use or leave battery packs in areas with temperatures above +60°C (+140°F). High temperature buildup in the battery, such as could occur near fires or stoves, inside a sun heated car, or in direct sunlight may cause the battery to rupture or catch fire. Excessive temperatures may also degrade battery performance or shorten battery life.

⚠ **DANGER! DO NOT** expose the battery to rain, snow, seawater, or any other liquids. Do not charge or use a wet battery. If the battery gets wet, be sure to wipe it dry before using. The battery is not waterproof.

⚠ **DANGER! NEVER** incinerate used battery packs since internal battery gas may cause them to rupture, or may cause an explosion.

⚠ **DANGER! NEVER** solder the battery terminals or NEVER modify the battery pack. This may cause heat generation, and the battery may rupture, emit smoke or catch fire.

⚠ **DANGER!** Use the battery only with the transceiver for which it is specified. Never use a battery with any other equipment, or for any purpose that is not specified in this instruction manual.

⚠ **DANGER!** If fluid from inside the battery gets in your eyes, blindness can result. Rinse your eyes with clean water, without rubbing them, and see a doctor immediately.

WARNING! Immediately stop using the battery if it emits an abnormal odor, heats up, or is discolored or deformed. If any of these conditions occur, contact your Icom dealer or distributor.

WARNING! Immediately wash, using clean water, any part of the body that comes into contact with fluid from inside the battery.

WARNING! NEVER put the battery in a microwave oven, high-pressure container, or in an induction heating cooker. This could cause a fire, overheating, or cause the battery to rupture.

CAUTION! Always use the battery within the specified temperature range for the transceiver (–10°C to +60°C; +14°F to +140°F) and the battery itself (–20°C to +60°C; –4°F to +140°F). Using the battery out of its specified temperature range will reduce the battery's performance and battery life. Please note that the specified temperature range of the battery may exceed that of the transceiver. In such cases, the transceiver may not work properly because it is out of its operating temperature range.

CAUTION! Shorter battery life could occur if the battery is left fully charged, completely discharged, or in an excessive temperature environment (above +45°C; +113°F) for an extended period of time. If the battery must be left unused for a long time, it must be detached from the radio after discharging. You may use the battery until the remaining capacity is about half, then keep it safely in a cool dry place with the temperature between –20°C to +50°C (–4°F to +122°F) for a month storing, between –20°C to +35°C (–4°F to +95°F) for three months storing and between –20°C to +20°C (–4°F to +68°F) for a year storing.

◇ Charging caution

⚠ **DANGER! NEVER** charge the battery pack in areas with extremely high temperatures, such as near fires or stoves, inside a sun heated car, or in direct sunlight. In such environments, the safety/protection circuit in the battery will activate, causing the battery to stop charging.

WARNING! NEVER charge or leave the battery in the battery charger beyond the specified time for charging. If the battery is not completely charged by the specified time, stop charging and remove the battery from the battery charger. Continuing to charge the battery beyond the specified time limit may cause a fire, overheating, or the battery may rupture.

WARNING! NEVER insert the transceiver (battery attached to the transceiver) into the charger if it is wet or soiled. This could corrode the battery charger terminals or damage the charger. The charger is not waterproof.

CAUTION! DO NOT charge the battery outside of the specified temperature range: BC-179 (0°C to +40°C; +32°F to +104°F). Icom recommends charging the battery at +20°C (+68°F). The battery may heat up or rupture if charged out of the specified temperature range. Additionally, battery performance or battery life may be reduced.

7 BATTERY PACKS

■ Charging the battery

◇ Regular charging with the BC-179+BC-174

The BC-179 provides regular charging of battery packs. The following are additionally required.

- An AC adapter (may be supplied with the transceiver depending on versions) or the optional cigarette lighter cable (CP-22).

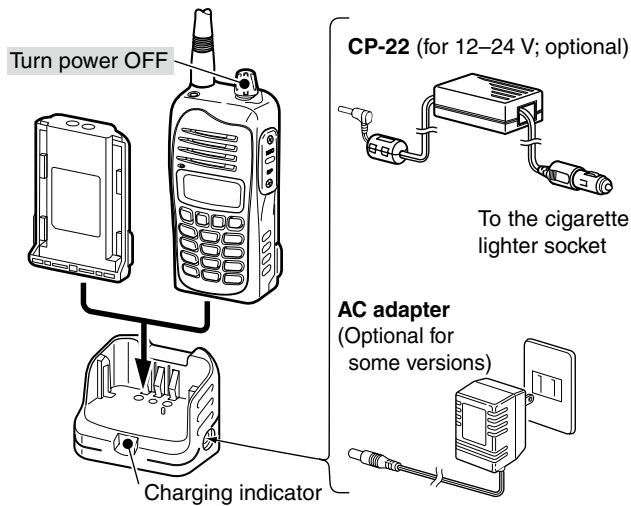

/// Be sure to turn the transceiver power OFF, when charging the battery pack with the transceiver.

CAUTION!

- **DO NOT** modify the CP-22. A modification could cause a fire or electric shock.
- **BE CAREFUL** not to cut or fray the CP-22's power cable when disconnecting/connecting the CP-22 from/to the cigarette lighter socket.

• Charging period

Approx. 12 hrs. (with BP-232N)

• Charging indicator color information

Orange : During charge

Green : Charging is completed

Orange or green (blink)

: The inserted battery pack or the charger has problem.

◇ **AD-106 installation**

➔ Connect the BC-119N/BC-121N (①), then install the AD-106 into the holder space of the BC-119N/BC-121N with the supplied screws (②).

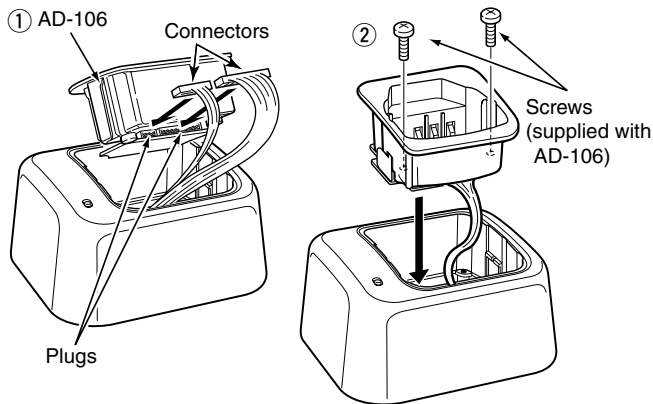

◇ **Rapid charging with the BC-119N+AD-106**

The optional BC-119N provides rapid charging of battery packs. The following are additionally required.

- AD-106 charger adapter.
- An AC adapter (may be supplied with BC-119N depending on versions) or the DC power cable (OPC-515L).

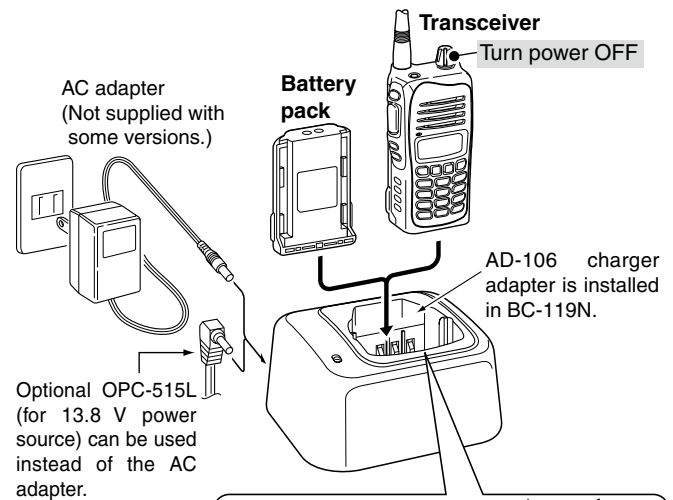

IMPORTANT!: Ensure the guide lobes on the battery pack are correctly aligned with the guide rails inside the charger adapter.

7 BATTERY PACKS

◇ Rapid charging with the BC-121N+AD-106

The optional BC-121N allows up to 6 battery packs to be charged simultaneously. The following are additionally required.

- Six AD-106 charger adapters.
- An AC adapter (BC-157) or the DC power cable (OPC-656).

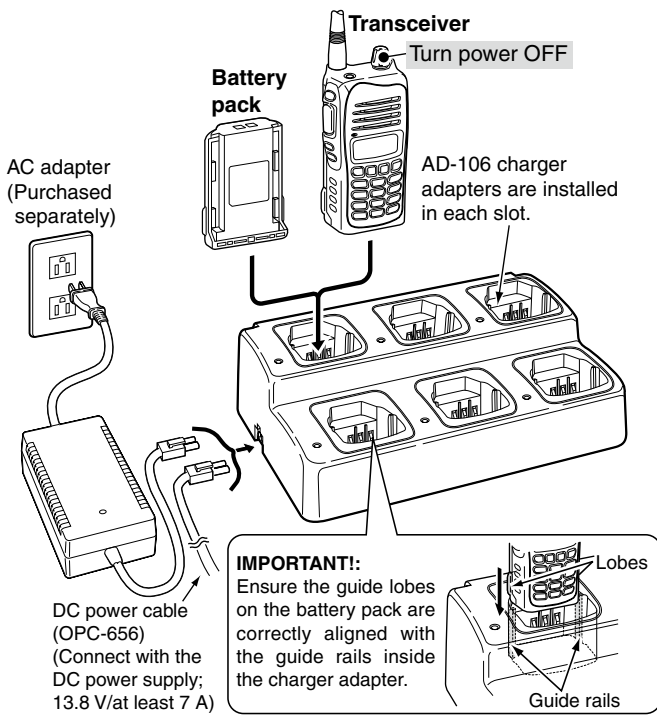

Cloning allows you to quickly and easily transfer the programmed data from one transceiver to another transceiver, or, data from PC to a transceiver using the optional CS-A14 cloning software.

◆ Transceiver to transceiver cloning

- ① Connect the OPC-474 CLONING CABLE to [MIC/SP] jack of the master and sub transceivers.
 - The master transceiver is used to send data to the sub transceiver.

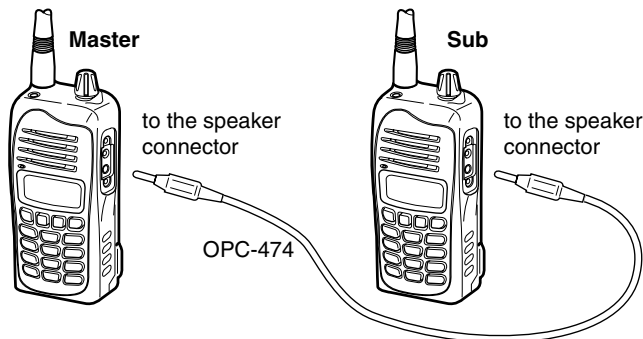

- ② While pushing and holding [MR], rotate [VOL] to enter cloning mode (for operating the master transceiver only).
 - "CLONE" appears and the transceivers enter the clone standby condition.

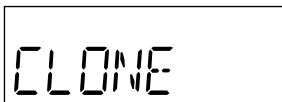

- ③ Push [PTT] on the master transceiver.
 - "CL.OUT" appears in the master transceiver's display.
 - "CL.IN" appears automatically in the sub transceiver's display.

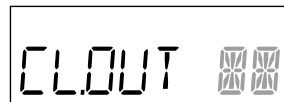

Master transceiver's indication during clone

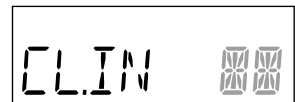

Sub transceiver's indication during clone

- ④ When cloning is finished, turn power OFF, then ON again to exit cloning mode.

/// **NOTE:** Transceiver to transceiver cloning between IC-A14 and IC-A14S cannot be performed.

8 CLONING

◇ Cloning using PC

Data can be cloned to and from a PC (Microsoft® Windows® 2000/XP and Windows Vista™) using the optional CS-A14 CLONING SOFTWARE and the optional OPC-478 (RS-232C type) or OPC-478UC (USB type) CLONING CABLE. Consult the CS-A14 CLONING SOFTWARE HELP file for details.

◇ Cloning error

When the display as below appears, a cloning error has occurred.

In this case, both transceivers automatically return to the clone standby condition and cloning must be repeated.



Microsoft, Windows and Windows Vista are registered trademarks or trademarks of Microsoft Corporation in the U.S.A. and/or other countries.

TROUBLESHOOTING

9

If your transceiver seems to be malfunctioning, please check the following points before sending it to a service center.

PROBLEM	POSSIBLE CAUSE	SOLUTION	REF.
No power comes on.	<ul style="list-style-type: none"> The battery is exhausted. Bad connection for the battery pack. 	<ul style="list-style-type: none"> Recharge the battery pack. Check the connection to the transceiver. 	pgs. 29–31 p. 7
No sound comes from the speaker.	<ul style="list-style-type: none"> Squelch level is too deep. Volume level is too low. 	<ul style="list-style-type: none"> Set squelch to the threshold point. Set [VOL] to a suitable level. 	p. 9
Transmitting impossible.	<ul style="list-style-type: none"> WX channels or NAVI band is selected. The battery is exhausted. 	<ul style="list-style-type: none"> Set COM band in frequency mode. Recharge the battery pack. 	p. 8 pgs. 29–31
Operating frequency or memory channel can not be changed.	<ul style="list-style-type: none"> Lock function is activated. 	<ul style="list-style-type: none"> Push and hold [L-O] for 2 sec. to turn the lock function OFF. 	p. 9
Scan does not start.	<ul style="list-style-type: none"> All memory channels in the selected bank are not programmed as “TAG” channels. Squelch is open. There is not more than 2 memorized channels 	<ul style="list-style-type: none"> Set the “TAG” settings of desired channels. Set the squelch level to tighten. Program 2 or more memory channels. 	p. 20 p. 9 pgs. 13, 14
No beep sounds.	<ul style="list-style-type: none"> Beep tones turned OFF. 	<ul style="list-style-type: none"> Turn the beep tone ON; <ul style="list-style-type: none"> IC-A14: Push [FUNC], then push [BEEP](8). IC-A14S: Turn the beep tone ON in set mode. 	p. 22 pgs. 22, 25

◇ CP-22 fuse replacement

If the fuse blows or the receiver stops functioning while operating with the optional CP-22 CIGARETTE LIGHTER CABLE, find the source of the problem if possible, and replace the damaged fuse with a new rated one (FGB 8 A) as shown right.

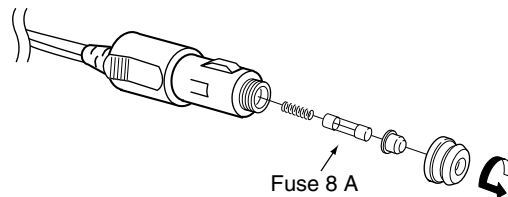

10 SPECIFICATIONS

◇ General

- Frequency coverage :
 - IC-A14 TX 118.000 to 136.975 MHz
 - RX 108.000 to 136.975 MHz
 - WX (Rx only) 161.650 to 163.275 MHz
 - IC-A14S TX/RX 118.000 to 136.975 MHz
- Mode : 6K00A3E
16K0G3E (IC-A14/Rx only)
- Channel spacing : 25 kHz
- Number of memory channels :
 - IC-A14 200 (20 CH × 10 BANKS)
 - IC-A14S 100
- Power supply requirement : Specified Icom's battery packs
7.4 V DC standard
- Usable temperature range : -10°C to +60°C (+14°F to +140°F)
- Current drain (at 7.4 V DC) :
 - Tx 1.5 A
 - Rx at stand by 50 mA typical
 - at AF max. 500 mA
- Antenna connector : BNC 50 Ω (nominal)
- Dimensions : 53(W) × 120(H) × 36.9(D) mm
(projections not included) 2³/₃₂(W) × 4²³/₃₂(H) × 1⁹/₁₆(D) inch
- Weight : Approx. 180 g (6.35 oz)
(Without the battery pack and antenna.)

◇ Transmitter

- Output power : 5.0 W (PEP) typical
1.5 W (CW)
- Modulation : Low level modulation
- Modulation limiting : 70 to 100%
- Frequency stability : ±5 ppm

- Audio harmonic distortion : Less than 10% (at 60% mod.)
- Hum and noise ratio : More than 35 dB
- Spurious emissions : More than 46 dB (except operating frequency ±62.5 kHz range)
- External MIC connector : 3-conductor 2.5(d) mm (1/10")/
150 Ω

◇ Receiver

- Receive system : Double conversion superheterodyne
- Intermediate frequencies : 1st 46.35 MHz, 2nd 450 kHz
- Sensitivity :
 - COM band (6 dB S/N) -6 dBμ typical
 - NAVI band (6 dB S/N) -3 dBμ typical (IC-A14 only)
 - WX channels (12 dB SINAD) -13 dBμ typical (IC-A14 only)
- Squelch sensitivity (threshold) : AM Less than 0 dBμ
FM Less than -5 dBμ
(IC-A14 only)
- Selectivity : 6 dB (More than 7.5 kHz)
60 dB (Less than 25 kHz)
- Spurious response rejection : AM More than 60 dB
FM More than 30 dB
(IC-A14 only)
- Audio output power : More than 700 mW (internal SP)
(at 10% distortion with an 8 Ω load, 30% mod.) More than 500 mW (external SP)
- Hum and noise : More than 35 dB at 30% mod.
- External SP connector : 3-conductor 3.5 (d) mm (1/8")/8 Ω

All stated specifications are subject to change without notice or obligation.

◇ BATTERY PACKS

- **BP-230N** Li-Ion BATTERY PACK
7.4 V/980 mAh Li-ion battery pack.
- **BP-232N** Li-Ion BATTERY PACK
7.4 V/2000 mAh Li-ion battery pack.

◇ CHARGERS

- **BC-119N** DESKTOP CHARGER + **AD-106** CHARGER ADAPTER
+ **BC-145** AC ADAPTER
For rapid charging of battery packs. An AC adapter is supplied with the charger depending on versions.
Charging time: approx. 3 hours when BP-232N is attached.
- **BC-121N** MULTI-CHARGER + **AD-106** CHARGER ADAPTER (6 pcs.)
+ **BC-157** AC ADAPTER
For rapid charging of up to 6 battery packs (six AD-106's are required) simultaneously. An AC adapter should be purchased separately. Charging time: approx. 3 hours when BP-232N is attached.
- **BC-160** DESKTOP CHARGER + **BC-145** AC ADAPTER
For rapid charging of BP-230N and BP-232N (Li-ion).
- **BC-171** DESKTOP CHARGER + **BC-147** AC ADAPTER
For regular charging of BP-230N and BP-232N (Li-ion).
- **BC-179** DESKTOP CHARGER + **BC-174** AC ADAPTER
For regular charging of BP-230N and BP-232N (Li-ion).

◇ MICROPHONE

- **HM-173** SPEAKER MICROPHONE
Combination speaker and microphone.

Available options may differ according to countries. Ask your authorized dealer for details.

◇ BELT CLIPS

- **MB-94** BELT CLIP
Alligator type belt clip.
- **MB-96F** LEATHER BELT HANGER
Attaches with the supplied belt clip (Fixed type).

◇ DC CABLES

- **CP-22** CIGARETTE LIGHTER CABLE
DC-DC converter is built-in. Charges the battery pack using 12/24 V DC power source instead of the AC adapter for BC-171/179.
- **OPC-515L** DC POWER CABLE FOR BC-119N
Charges the battery pack using 13.8 V power source instead of the AC adapter for BC-119N.
- **OPC-656** DC POWER CABLE FOR BC-121N
Charges the battery pack using 13.8 V power source instead of the AC adapter for BC-121N.

◇ OTHER OPTIONS

- **CS-A14** CLONING SOFTWARE + **OPC-478/UC** CLONING CABLE
Provides quick and easy programming of items, such as memory channels or set mode contents, from a PC using the cloning cable, OPC-478 (RS-232C; DB-9 type) or OPC-478UC (USB type).
- **OPC-499** HEADSET ADAPTER CABLE
When using an optional headset (3rd party products) via the adapter, the transceiver outputs your transmitted voice to the headset for monitoring.
- **OPC-474** CLONING CABLE
For data cloning between transceivers.

12 OPTIONAL HEADSET CONNECTION

◇ OPC-499 (HEADSET ADAPTER) connection

When using a headset (3rd party products) via the OPC-499 HEADSET ADAPTER, the transceiver outputs your transmitted voice to the headset for monitoring. See “■ Side tone function” (p. 11) when setting the side tone level.

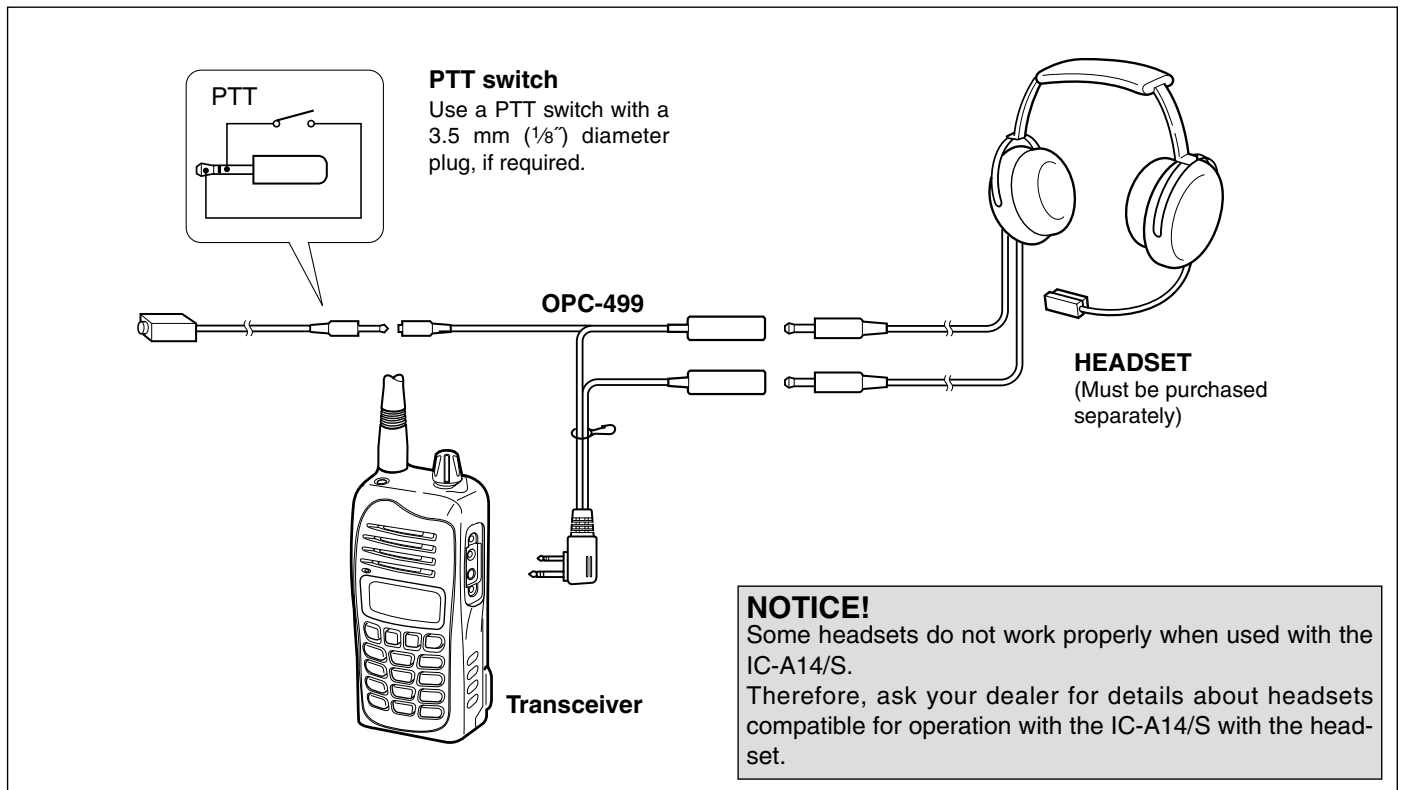

Count on us!



A-6631H-1EX
Printed in Japan
© 2007 Icom Inc.
Printed on recycled paper with soy ink.

Icom Inc.
1-1-32 Kamiminami, Hirano-ku, Osaka 547-0003, Japan